

DV-5 Deluge Valve Diaphragm Style

General Description

The TYCO 1-1/2 inch to 8 inch (DN40 to DN200), DV-5 Deluge Valves are diaphragm type valves designed for vertical or horizontal installation and for fire protection system service. They are used as automatic water control valves in deluge, preaction, and special types of fire protection systems such as foam-water and double interlock systems. When properly trimmed, the DV-5 Valves are also able to provide actuation of fire alarms upon system operation.

NOTICE

These valves are to be used only for hydraulically calculated systems.

The diaphragm style design of the DV-5 Valve allows external resetting, providing for easy resetting of a deluge or preaction system without having to open a valve handhole cover to manually reposition a clapper and/or latch mechanism. Simply repressurizing the diaphragm chamber resets the valve.

The one-piece, diaphragm style design of the DV-5 also allows internal and external coating of the valve to provide corrosion resistance. The internal corrosion resistance offered by the RILSAN coating makes the DV-5 suitable for most seawater and brackish water supplies when utilized in deluge systems. The external corrosion resistance of the RILSAN coating permits the use of the DV-5 in corrosive atmospheres associated with many types of industrial processing plants and outdoor installations.

NOTICE

The DV-5 Deluge Valves described herein must be installed and maintained in compliance with this document and with the applicable standards of the National Fire Protection Association, in addition to the standards of any other authorities having jurisdiction. Failure to do so may impair the performance of these devices.



End Connections Available and Weights

End Connection		Nominal Valve Size					
Inlet	Outlet	1-1/2 Inch (DN40)	2 Inch (DN50)	3 Inch (DN80)	4 Inch (DN100)	6 Inch (DN150)	8 Inch (DN200)
Thread	Thread	9 lb (4,1 kg)	12 lb (5,4 kg)	N/A	N/A	N/A	N/A
Groove	Groove ¹	8 lb (3,6 kg)	10 lb (4,5 kg)	31 lb (14,1 kg)	61 lb (27,7 kg)	99 lb (44,9 kg)	150 lb (68,1 kg)
Flange	Groove ¹	N/A	N/A	39 lb (17,7 kg)	74 lb (33,6 kg)	107 lb (48,5 kg)	170 lb (77,8 kg)
Flange	Flange	N/A	N/A	47 lb (21,3 kg)	80 lb (36,3 kg)	115 lb (52,3 kg)	190 lb (87,5 kg)

Notes:

1. The Grooved Outlet is recommended for use in Praction Systems to accommodate the use of a Groove x Groove Riser Check Valve. Refer to Technical Data Sheet TFP1410, TFP1415, TFP1420, TFP1460, or TFP1465 as applicable.

The owner is responsible for maintaining their fire protection system and devices in proper operating condition. Contact the installing contractor or product manufacturer with any questions.

VALVE PARTS				NOTES:	REPLACEMENT PARTS				
No.	Description	Qty.	Repair Parts		No.	Description P/N			
1	Valve Body	1	NR	<ol style="list-style-type: none"> NR - Not Replaceable CH - Common Hardware Valve Bodies of 4, 6 and 8 Inch (DN100, DN150 & DN200) valves are equipped with studs and Valve Covers are secured by Hex Nuts and Hex Bolts. V-Ring is attached to Diaphragm of 4, 6 and 8 Inch (DN100, DN150 & DN200) valves at factory. If, during internal valve inspection, V-Ring is discovered to be detached from Diaphragm, be advised that V-Ring is a required valve component and that detachment will not affect normal valve operation or performance. Should V-Ring become detached, reinstall between Diaphragm and Diaphragm Cover concentrically as shown. <p>NOTE: Do not apply adhesives, lubricants, or other substances to Diaphragm, V-Ring, or Valve Body.</p>	(a)	Diaphragm Kit			
2	Diaphragm	1	(a)		1-1/2 Inch (DN40) Valve	92-477-1-105			
3	Diaphragm Cover	1	NR		2 Inch (DN50) Valve	92-477-1-107			
4	Flat Washer, Metric: 1-1/2 Inch (DN40) Valve, M12	4	CH		3 Inch (DN80) Valve,	92-477-1-109			
					4 Inch (DN100) Valve & 6 Inch (DN150) Valve, M16	92-477-1-101			
					8 Inch (DN200) Valve, M20	92-477-1-103			
					8 Inch (DN200) Valve, M20	92-477-1-111			
5	Hex Bolt, Metric: 1-1/2 Inch (DN40) Valve, M12 x 30 mm	4	CH		2 Inch (DN50) Valve & 3 Inch (DN80) Valve, M16 x 50 mm	CH			
					4 Inch (DN100) Valve, M16 x 50 mm	CH			
					6 Inch (DN150) Valve, M16 x 55 mm	CH			
				8 Inch (DN200) Valve, M20 x 70 mm	CH				
				6	Hex Nut, Metric: 4 Inch (DN100) Valve & 6 Inch (DN150) Valve, M16	2	CH	8 Inch (DN200) Valve, M20	CH
								4 Inch (DN100) Valve & 6 Inch (DN150) Valve, M16	CH
								8 Inch (DN200) Valve, M20	CH
								8 Inch (DN200) Valve, M20	CH

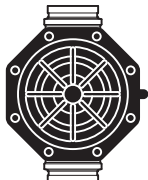

ORIENT
DIAPHRAGM TAB
PERPENDICULAR
TO VALVE BODY
CENTERLINE

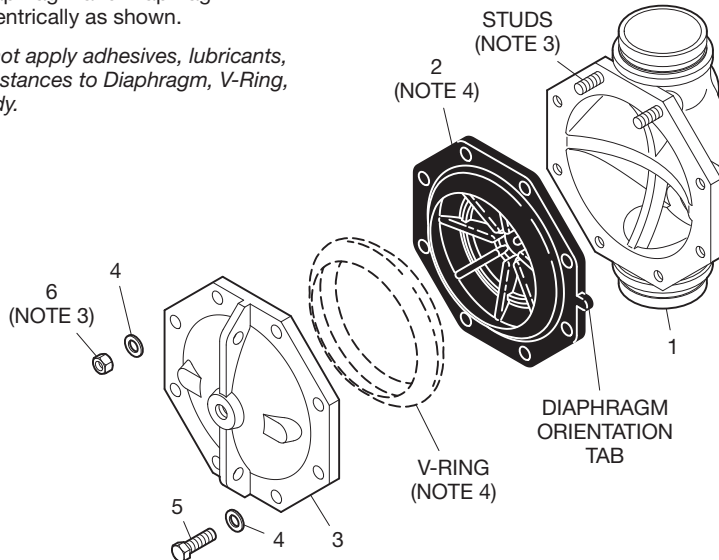

STUDS
(NOTE 3)
2
(NOTE 4)
DIAPHRAGM
ORIENTATION
TAB
V-RING
(NOTE 4)
6
(NOTE 3)
4
5
4
3

**FIGURE 1
DV-5 DELUGE VALVE
ASSEMBLY**

Nominal Valve Size ¹	Flange Drilling Specification														
	Nominal Dimensions in Inches and (mm)														
	ANSI B16.1 (Class 125) ²			ISO 7005-2 (PN10) ³			ISO 7005-2 (PN16) ⁴			JIS B 2210 (10K)			AS 2129 (Table E)		
	A	B	N	A	B	N	A	B	N	A	B	N	A	B	N
3 Inch (DN80)	6.00 (152,4)	0.75 (19,0)	4	USE ISO 7005-2 (PN16)	6.30 (160,0)	0.75 (19,0)	8	N/A			N/A				
4 Inch (DN100)	7.50 (190,5)	0.75 (19,0)	8		7.09 (180,0)	0.75 (19,0)	8	6.89 (175,0)	0.60 (15,0)	8	7.00 (178,0)	0.71 (18,0)	8		
6 Inch (DN150)	9.50 (241,3)	0.88 (22,2)	8		9.45 (240,0)	0.91 (23,0)	8	9.45 (240,0)	0.75 (19,0)	8	9.25 (235,0)	0.87 (22,0)	8		
8 Inch (DN200)	11.75 (298,5)	0.88 (22,2)	8	11.61 (295,0)	0.91 (23,0)	8	11.61 (295,0)	0.91 (23,0)	12	N/A			11.50 (292,0)	0.87 (22,0)	8

Notes:

- Flange end 1-1/2 & 2 Inch (DN40 & DN50) DV-5 Valves are not offered.
- Same drilling as for B16.5 (Class 150) and B16.42 (Class 250).
- Same drilling as for BS 4504 Section 3.2 (PN10) and DIN 2532 (PN10).
- Same drilling as for BS 4504 Section 3.2 (PN16) and DIN 2532 (PN16).

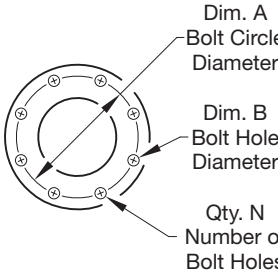

Dim. A
Bolt Circle Diameter

Dim. B
Bolt Hole Diameter

Qty. N
Number of Bolt Holes

**TABLE A
DIMENSIONAL SPECIFICATIONS
FOR SELECTION OF FLANGE DRILLING**

Port Description	Port	Port Sizes in NPT per ANSI B1.20.1 *					
		1-1/2 Inch (DN40)	2 Inch (DN50)	3 Inch (DN80)	4 Inch (DN100)	6 Inch (DN150)	8 Inch (DN200)
Diaphragm Chamber Supply	P1	1/2"	1/2"	1/2"	1/2"	1/2"	1/2"
Water Supply Pressure & Alarm Test	P2	1/2"	1/2"	1/2"	1/2"	1/2"	1/2"
Alarm Actuation & System Drain	P3	3/4"	3/4"	3/4"	1"	1"	1"
Main Drain	P4	3/4"	3/4"	1-1/4"	2"	2"	2"
Diaphragm Chamber Supply Automatic Shut-Off Valve Actuation	P5	1/2"	1/2"	1/2"	1/2"	1/2"	1/2"

* Valves are available with ports threaded per ISO 7-1

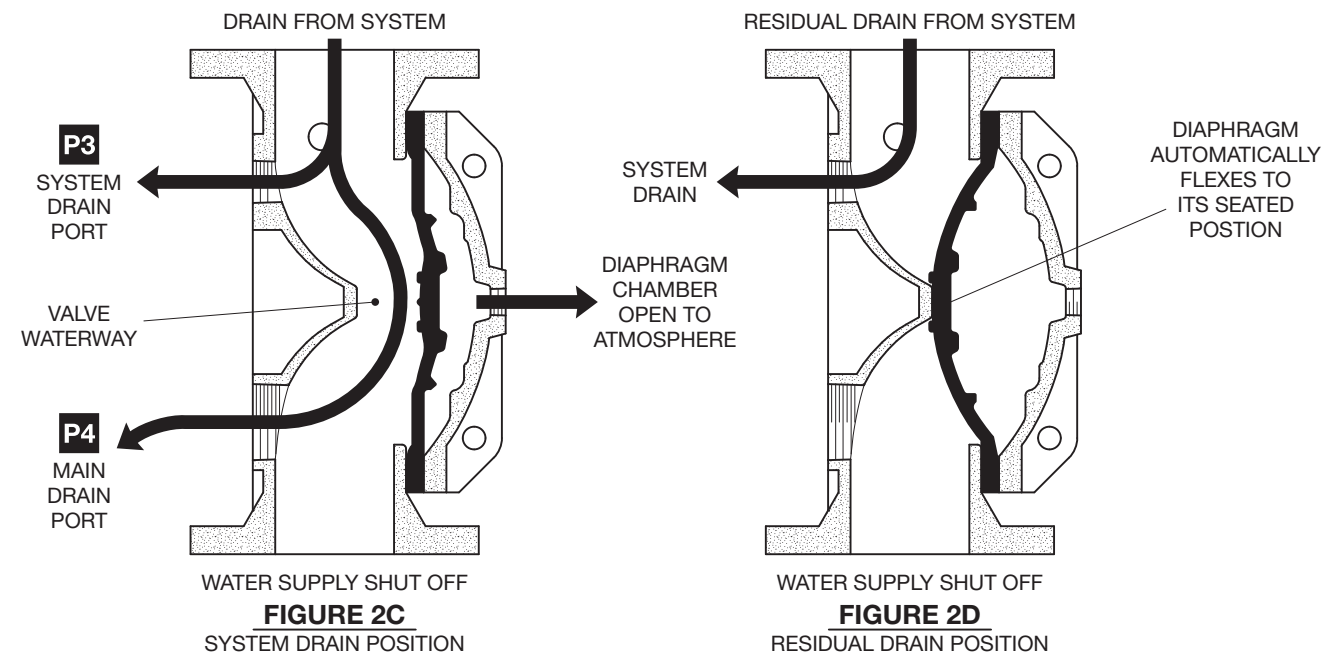
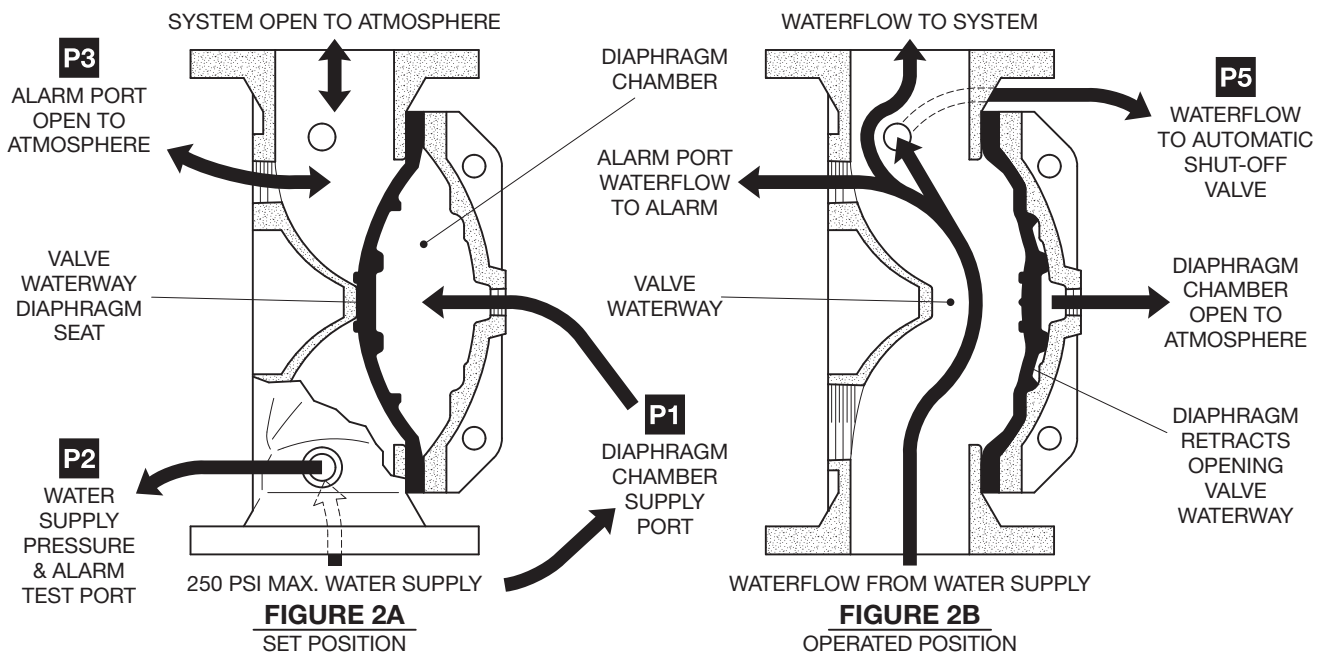
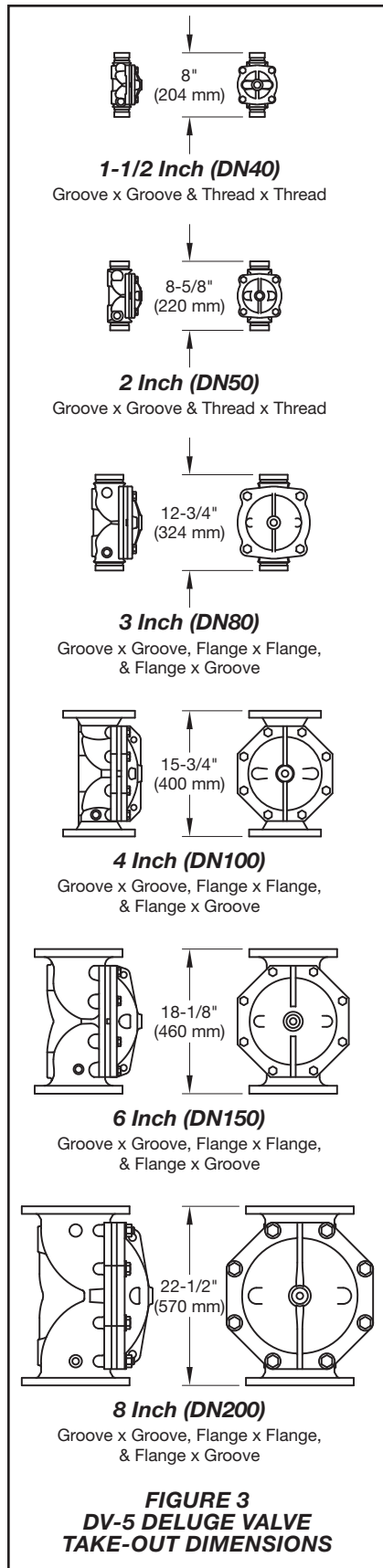

FIGURE 2
DV-5 DELUGE VALVE
SET AND OPEN POSITIONS



Technical Data

Approvals

UL and C-UL Listed for hydraulically calculated systems, and FM Approved, when trimmed per the following Technical Data Sheets:

- **Deluge Systems:**
TFP1310 -Wet Pilot Actuation
TFP1315 -Dry Pilot Actuation
TFP1320 -Electric Actuation
- **Single Interlock Preaction Systems:**
TFP1410 -Wet Pilot Actuation*
TFP1415 -Dry Pilot Actuation*
TFP1420 -Electric Actuation
*UL and C-UL only
- **Double Interlock Preaction Systems:**
TFP1460 -Electric/Pneumatic
TFP1465 -Electric/Electric

Deluge Valve

Components for the 1-1/2 inch to 8 inch (DN40 to DN200), DV-5 Deluge Valves are shown in Figure 1. The DV-5 Valves are for vertical or horizontal installations, and they are rated for use at a maximum service pressure of 250 psi (17,2 bar).

The take-out dimensions are shown in Figure 3, and the flanged connections are available drilled per ANSI, ISO, AS, and JIS specifications (Ref. Table A).

Threaded port connections of the DV-5 Valves are available NPT threaded or threaded per ISO 7/1 as detailed in the Ordering Procedure section. Valves with NPT threaded ports will readily accept the trim arrangements detailed in Technical Data Sheets referenced under "Approvals".

Materials of Construction

NOTICE

The RILSAN coating for the DV-5 Valve provides corrosion resistance and is intended to extend the life of the DV-5 Valve when exposed to internal and external corrosive conditions. Although the RILSAN coating is intended to resist corrosion, it is recommended that the end user or other technical expert familiar with conditions at the proposed installation be consulted with respect to the suitability of this coating for a given corrosive condition.

Deluge systems using a seawater or brackish water supply require special considerations in order to extend the life of the valve and trim. This type of system ideally should be configured with a primary source of clean fresh water (e.g., a pressurized water tank) and only upon system operation is the secondary water supply (seawater or brackish water) allowed to enter the system. After the system operation, the system should then be thoroughly flushed with clean fresh water. Following this recommendation will increase the service life of the DV-5 Valve and Valve Trim.

Body

RILSAN polyamide 11 coated ductile iron per ASTM A536-77, Grade 65-45-12

Handhole Cover

RILSAN polyamide 11 coated ductile iron per ASTM A536-77, Grade 65-45-12

Diaphragm

Nylon fabric reinforced, natural rubber per ASTM D2000

V-Ring

Natural rubber per ASTM D2000

Diaphragm Cover Fasteners

Galvanized carbon steel

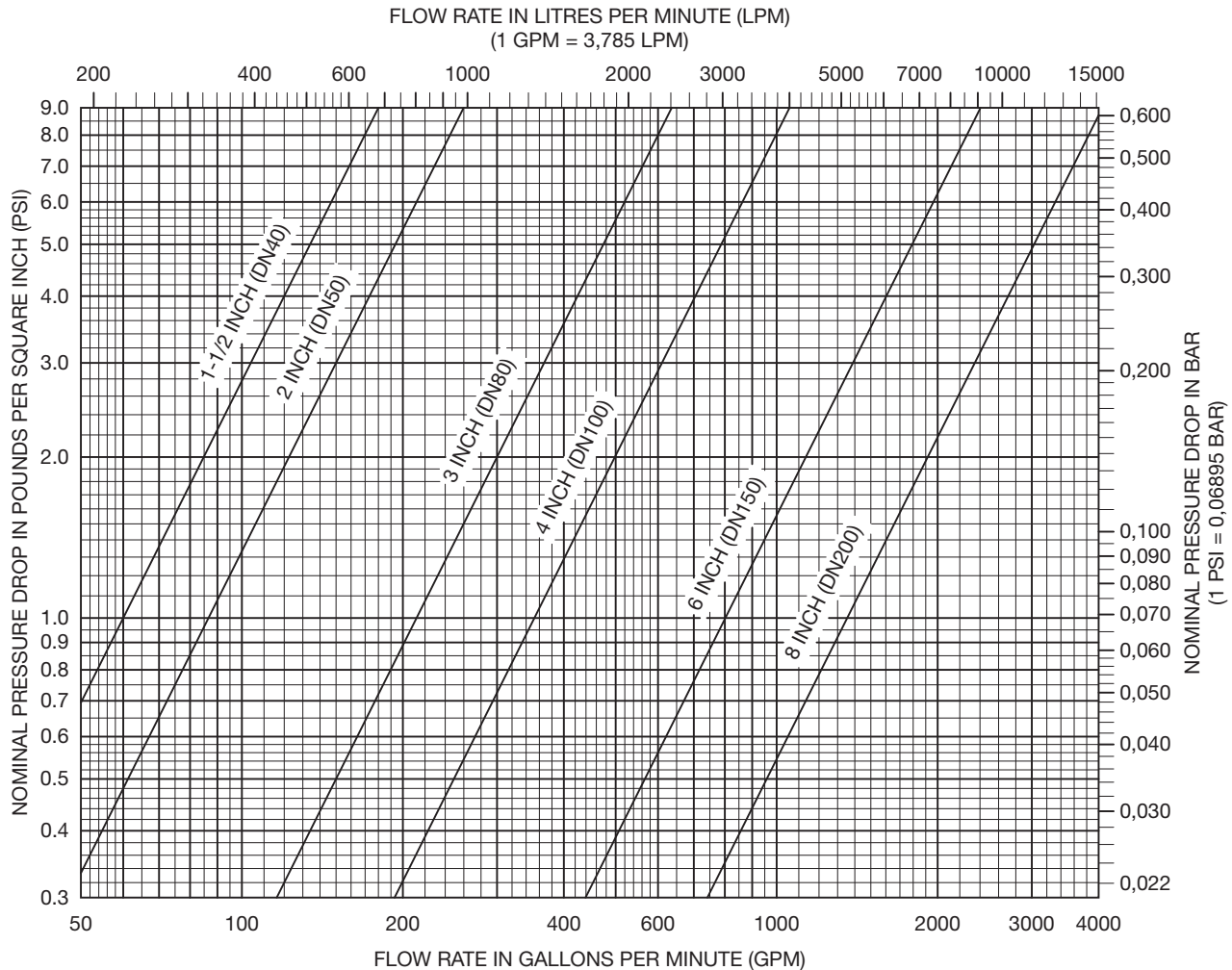

The approximate friction loss, based on the Hazen and Williams formula and expressed in equivalent length of pipe with C=120, is as follows:

- 16 feet of 2 inch Sch. 40 pipe for the 2 inch DV-5 Valve calculated on a typical flow rate of 175 GPM.
- 20 feet of 3 inch Sch. 40 pipe for the 3 inch DV-5 Valve calculated on a typical flow rate of 350 GPM.
- 29 feet of 4 inch Sch. 40 pipe for the 4 inch DV-5 Valve calculated on a typical flow rate of 600 GPM.
- 46 feet of 6 inch Sch. 40 pipe for the 6 inch DV-5 Valve calculated on a typical flow rate of 1500 GPM.
- 72 feet of 8 inch Sch. 30 pipe for the 8 inch DV-5 Valve calculated on a typical flow rate of 2500 GPM.

GRAPH A
DV-5 DELUGE VALVE
NOMINAL PRESSURE LOSS VERSUS FLOW

Operating Principles

The TYCO DV-5 Deluge Valve is a diaphragm style valve that depends upon water pressure in the Diaphragm Chamber (Ref. Figure 2A) to hold the Diaphragm closed against the water supply pressure. When the DV-5 Valve is set for service, the

Diaphragm Chamber is pressurized through the trim connections from the inlet side of the system's main control valve. Opening an actuation device, for example the solenoid valve in the Electric Actuation Trim (Ref. Technical Data Sheet TFP1320), releases water from the Diaphragm Chamber faster than it can be replenished through an 1/8 inch (3,2 mm) restriction provided by the diaphragm chamber supply connection

provided in the applicable trim arrangements. This results in a rapid pressure drop in the Diaphragm Chamber and the force differential applied through the Diaphragm to hold the Diaphragm in the set position is reduced below the valve trip point. The water supply pressure then forces the Diaphragm open, permitting water to flow into the system piping.

Installation

NOTICE

Proper operation of the DV-5 Deluge Valves depends upon their trim being installed in accordance with the instructions given in their respective Technical Data Sheet. Failure to follow the appropriate trim diagram may prevent the DV-5 Valve from functioning properly, as well as void listings, approvals, and the manufacturer's warranties. The DV-5 Valve must be installed in a readily visible and accessible location. The DV-5 Valve, associated trim, and wet pilot lines must be maintained at a minimum temperature of 40°F (4,4°C). Heat tracing of the DV-5 Valve or its associated trim is not permitted. Heat tracing can result in the formation of hardened mineral deposits that are capable of preventing proper operation. Before a system hydrostatic test is performed refer to the Installation section of Technical Data Sheets TFP1310, TFP1315, TFP1320, TFP1410, TFP1415, TFP1420, TFP1460, or TFP1465.

Care and Maintenance

The following procedures and inspections must be performed as indicated, in addition to any specific requirements of the NFPA. Any impairment must be immediately corrected.

Before closing a fire protection system main control valve for maintenance work on the fire protection system that it controls, obtain permission to shut down the affected fire protection system from the proper authorities and notify all personnel who may be affected by this action.

The owner is responsible for the inspection, testing, and maintenance of their fire protection system and devices in compliance with this document, as well as with the applicable standards of the National Fire Protection Association (e.g., NFPA 25), in addition to the standards of any other authorities having jurisdiction. Contact the installing contractor or product manufacturer with any questions.

Automatic sprinkler systems should be inspected, tested, and maintained by a qualified Inspection Service in accordance with local requirements and/or national code.

When the system is using either a seawater or brackish water supply, internal and external inspection of the DV-5 Valve and Trim is essential. Parts showing any signs of corrosion must be replaced to ensure the integrity of the system.

Drop in Water Supply Pressure Below Normal Range

NOTICE

If the water supply pressure is significantly reduced below the normally expected static pressure range (as could occur in the case of a water main break or repair), and there is a subsequent drop in the diaphragm chamber water pressure below its normal range (due, for example, to a leak in a piping connection to or from the diaphragm chamber or, a leak in the diaphragm chamber check valve caused by dirt or debris in the check valve seal area), a deluge valve such as the DV-5 could inadvertently trip, if its water supply pressure is quickly restored.

A drop in the water supply pressure to below its normal range (as in the case of an interrupted water supply condition) constitutes an emergency impairment as defined by NFPA 25. Should this condition occur, immediately close the main control valve and utilize the following procedure to reset the system:

Step 1. Prior to the water supply pressure being restored to the closed main control valve, note the pressure indicated by the diaphragm chamber pressure gauge and determine if the pressure is within the normally expected range.

Step 2. If the diaphragm chamber pressure is below the normal range, check for and correct any source of leakage from the diaphragm chamber prior to resetting the system.

Step 3. After the water supply pressure is restored to the main control valve, reset the DV-5 Deluge Valve in accordance with the Valve Setting Procedure section.

NOTICE

For fire protection systems subject to an emergency impairment caused by an interrupted water supply condition, it is recommended that consideration be given to installing a low water supply pressure switch with the appropriate alarm/indications to monitor the water supply pressure.

Annual Operation Test Procedure

Proper operation of the DV-5 Valve (i.e., opening of the DV-5 Valve as during a fire condition) must be verified at least once a year as follows:

NOTICE

Operation tests for DV-5 Valves used in double interlock preaction systems must be performed as outlined in TFP1460 or TFP1465, as applicable.

Step 1. If water must be prevented from flowing beyond the riser, perform the following steps:

- Close the Main Control Valve.
- Open the Main Drain Valve.
- Open the Main Control Valve one turn beyond the position at which water just begins to flow from the Main Drain Valve.
- Close the Main Drain Valve.

Step 2. Determine the type of actuation/detection system, and operate the DV-5 Valve accordingly.

NOTICE

Be prepared to quickly perform Steps 3, 4, and 5 if water must be prevented from flowing beyond the riser.

- **Wet Pilot Actuation** — Open the Inspector's Test Connection.
- **Dry Pilot Actuation** — Open the Inspector's Test Connection.
- **Electric Actuation** — Test the deluge releasing panel (automatic control unit) in accordance with the manufacturer's instructions to energize the solenoid valve.

Step 3. Verify that the DV-5 Valve has tripped, as indicated by the flow of water into the system.

Step 4. Close the system's Main Control Valve.

Step 5. Close the Diaphragm Chamber Supply Control Valve.

Step 6. Reset the DV-5 Deluge Valve in accordance with the Valve Setting Procedure provided in TFP1310, TFP1315, TFP1320, TFP1410, TFP1415, or TFP1420, as applicable.

Internal Valve Inspection

Once every five years during the annual operational test procedure and prior to the DV-5 Valve being reset, the interior of the DV-5 Valve must be cleaned and inspected for wear and damage. Damaged or worn parts must be replaced. (Replacement of the Diaphragm every ten years is recommended.)

When reinstalling the Diaphragm Cover, complete the following steps to assure the Diaphragm Cover Fasteners (Hex Bolts) are uniformly and securely tightened.

Nominal Valve Sizes Inches (DN)	Torque lb-ft (N-m)
1-1/2 (DN40)	22 (29,82)
2 (DN50)	29 (39,32)
3 (DN80)	54 (73,21)
4 (DN100)	65 (88,13)
6 (DN150)	72 (97,62)
8 (DN200)	87 (117,96)

TABLE B
DIAPHRAGM COVER BOLTS
MAXIMUM TORQUE

Step 1. Align Diaphragm and Diaphragm Cover in proper orientation with valve body (Ref. Figure 1) and hold in place

Step 2. Assemble Flat Washers onto Hex Bolts

Step 3. Apply LOCTITE No. 242 (or equivalent) to Hex Bolt threads

Step 4. Insert Hex Bolts through Diaphragm Cover and Diaphragm, hand-tighten into valve body

Step 5. Using crossdraw sequence to assure uniformity, wrench-tighten Hex Bolts to appropriate torque values (Ref. Table B)

Step 6. Inspect to assure all Hex Bolts are securely tightened

NOTICE

If the water supply contains chemicals which tend to attack a Nylon fabric reinforced, natural rubber or the five year inspection indicates a build-up of debris within the valve that could affect its proper operation, then the frequency of the internal valve inspection procedure must be appropriately increased.

If the system has a seawater or brackish water supply, then the frequency of the internal valve inspection procedure must be appropriately increased. (An annual internal valve inspection for a system having a seawater or brackish water supply is recommended.)

With reference to Figure 1, make certain that the Diaphragm is correctly oriented; otherwise, the DV-5 cannot be properly set.

Under-tightening the Diaphragm Cover Bolts can result in internal and external leakage.

The V-Ring is attached to the Diaphragm at the factory. If, during an internal valve inspection, the V-Ring is discovered to be detached from the Diaphragm, be advised that the V-Ring is a required valve component and that detachment will not affect normal valve operation or performance. Should the V-Ring become detached, reinstall it between the Diaphragm and Diaphragm Cover concentrically as shown in Figure 1.

NOTE: Do not apply adhesives, lubricants, or other substances to the Diaphragm, V-Ring, or Valve Body.

Limited Warranty

For warranty terms and conditions, visit www.tyco-fire.com.

Ordering Procedure

NOTICE

Refer to Table A for Flange Drilling Specifications.

Part Numbers for factory pre-trimmed DV-5 Valves are provided in the Price Book.

Standard DV-5 Deluge Valve (American Standard Flange Drilling, Threaded Ports, and Groove Outside Diameter, as applicable)

Specify: (specify size inch) DV5 Deluge Valve with (specify end connections), P/N (specify):

- 1-1/2 Inch G x G
1.90 inch (48,3 mm)
Groove O.D. x 1.90 inch (48,3 mm)
Groove O.D. 52-477-1-919
- 1-1/2 Inch T x T
NPT x NPT 52-477-1-069
- 2 Inch G x G
2.37 inch (60,3 mm)
Groove O.D. x 2.37 inch (60,3 mm)
Groove O.D. 52-477-1-910
- 2 Inch T x T
NPT x NPT 52-477-1-060
- 3 Inch G x G
3.50 inch (88,9 mm)
Groove O.D. x 3.50 inch (88,9 mm)
Groove O.D. 52-477-1-912
- 3 Inch F x F
ANSI Flange x
ANSI Flange 52-477-1-012
- 3 Inch F x G
ANSI Flange x
3.50 inch (88,9 mm)
Groove O.D. 52-477-1-412
- 4 Inch G x G
4.50 inch (114,3 mm)
Groove O.D. x 4.50 inch (114,3 mm)
Groove O.D. 52-477-1-913

- 4 Inch F x F
ANSI Flange x
ANSI Flange 52-477-1-013
- 4 Inch F x G
ANSI Flange x
4.50 inch (114,3 mm)
Groove O.D. 52-477-4-613
- 6 Inch G x G
6.62 inch (168,3 mm)
Groove O.D. x 6.62 inch (168,3 mm)
Groove O.D. 52-477-1-915
- 6 Inch F x F
ANSI Flange x
ANSI Flange 52-477-1-015
- 6 Inch F x G
ANSI Flange x
6.62 inch (168,3 mm)
Groove O.D. 52-477-4-615
- 8 Inch G x G
8.62 inch (219,1 mm)
Groove O.D. x 8.62 inch (219,1 mm)
Groove O.D. 52-477-1-916
- 8 Inch F x F
ANSI Flange x
ANSI Flange 52-477-1-016
- 8 Inch F x G
ANSI Flange x
8.62 inch (219,1 mm)
Groove O.D. 52-477-1-416

Replacement Valve Parts

Specify: (description) for use with (specify) size DV-5 Deluge Valve, P/N (see Figure 1)

See Page 8 for Other DV-5 Deluge Valves

Other DV-5 Deluge Valves

NOTICE

Other DV-5 Deluge Valves are valves ordered with any combination of flange, threaded port, or groove outside diameter not offered under “Standard DV-5 Deluge Valve” offerings.

Valves with NPT threaded ports are intended for use with the “Standard DV-5 Valve Trim” offered and detailed in Technical Data Sheets TFP1310, TFP1315, TFP1320, TFP1410, TFP1415, TFP1420, TFP1460, and TFP1465. Valves with ISO threaded ports are intended for use with special order trim that is provided by local distributors to meet the specific needs of certain localities. Please contact your local distributor regarding valves and valve trim for specific localities.

Specify: (specify size) DV-5 Deluge Valve with (specify) connections with (specify NPT or ISO) threaded ports, P/N (specify):

Part Numbers for Other DV-5 Deluge Valves

Other 1-1/2 Inch Valves with ISO Ports

ISO Thread x
 ISO Thread 52-477-1-169

Other 2 Inch Valves with ISO Ports

ISO Thread x
 ISO Thread 52-477-1-160

Other 3 Inch Valves with NPT Ports

ISO Flange x
 3.50 inch (88,9 mm)
 Groove O.D. 52-477-1-252

ISO Flange x
 ISO Flange 52-477-1-132

AS Flange x
 AS Flange 52-477-1-512

AS Flange x
 3.50 inch (88,9 mm)
 Groove O.D. 52-477-1-612

JIS Flange x
 JIS Flange 52-477-1-712

JIS Flange x
 3.50 inch (88,9 mm)
 Groove O.D. 52-477-1-812

Other 3 Inch Valves with ISO Ports

ISO Flange x
 ISO Flange 52-477-1-112

ISO Flange x
 3.50 inch (88,9 mm)
 Groove O.D. 52-477-1-212

3.50 inch (88,9 mm)
 Groove O.D. x
 3.50 inch (88,9 mm)
 Groove O.D. 52-477-1-922

Other 4 Inch Valves with NPT Ports

ISO Flange x
 4.50 inch (114,3 mm)
 Groove O.D. 52-477-5-213

ISO Flange x
 ISO Flange 52-477-5-113

AS Flange x
 AS Flange 52-477-4-313

AS Flange x
 4.50 inch (114,3 mm)
 Groove O.D. 52-477-4-413

JIS Flange x
 JIS Flange 52-477-4-713

JIS Flange x
 4.50 inch (114,3 mm)
 Groove O.D. 52-477-4-813

Other 4 Inch Valves with ISO Ports

ISO Flange x
 ISO Flange 52-477-4-113

ISO Flange x
 4.50 inch (114,3 mm)
 Groove O.D. 52-477-4-213

4.50 inch (114,3 mm)
 Groove O.D. x
 4.50 inch (114,3 mm)
 Groove O.D. 52-477-1-923

Other 6 Inch Valves with NPT Ports

ANSI Flange x
 6.50 inch (165,1 mm)
 Groove O.D. 52-477-4-225

ISO Flange x
 6.62 inch (168,3 mm)
 Groove O.D. 52-477-5-625

ISO Flange x
 6.50 inch (165,1 mm)
 Groove O.D. 52-477-5-215

ISO Flange x
 ISO Flange 52-477-5-115

6.50 inch (165,1 mm)
 Groove O.D. x
 6.50 inch (165,1 mm)
 Groove O.D. 52-477-1-935

AS Flange x
 AS Flange 52-477-4-315

AS Flange x
 6.62 inch (168,3 mm)
 Groove O.D. 52-477-4-415

AS Flange x
 6.50 inch (165,1 mm)
 Groove O.D. 52-477-5-415

JIS Flange x
 JIS Flange 52-477-4-715

JIS Flange x
 6.62 inch (168,3 mm)
 Groove O.D. 52-477-4-815

JIS Flange x
 6.50 inch (165,1 mm)
 Groove O.D. 52-477-5-815

Other 6 Inch Valves with ISO Ports

ISO Flange x
 ISO Flange 52-477-4-115

ISO Flange x
 6.62 inch (168,3 mm)
 Groove O.D. 52-477-4-625

ISO Flange x
 6.50 inch (165,1 mm)
 Groove O.D. 52-477-4-215

6.62 inch (168,3 mm)
 Groove O.D. x
 6.62 inch (168,3 mm)
 Groove O.D. 52-477-1-925

6.50 inch (165,1 mm)
 Groove O.D. x
 6.50 inch (165,1 mm)
 Groove O.D. 52-477-1-945

Other 8 Inch Valves with NPT Ports

ISO (PN10) Flange x
 8.62 inch (219,1 mm)
 Groove O.D. 52-477-1-256

ISO (PN10) Flange x
 ISO (PN10) Flange 52-477-1-136

ISO (PN16) Flange x
 ISO (PN16) Flange 52-477-1-146

AS Flange x
 AS Flange 52-477-1-516

AS Flange x
 8.62 inch (219,1 mm)
 Groove O.D. 52-477-1-616

JIS Flange x
 JIS Flange 52-477-1-716

JIS Flange x
 8.62 inch (219,1 mm)
 Groove O.D. 52-477-1-816

Other 8 Inch Valves with ISO Ports

ISO (PN10) Flange x
 ISO (PN10) Flange 52-477-1-116

ISO (PN16) Flange x
 ISO (PN16) Flange 52-477-1-126

ISO (PN10) Flange x
 8.62 inch (219,1 mm)
 Groove O.D. 52-477-1-216

ISO (PN16) Flange x
 8.62 inch (219,1 mm)
 Groove O.D. 52-477-1-226

8.62 inch (219,1 mm)
 Groove O.D. x
 8.62 inch (219,1 mm)
 Groove O.D. 52-477-1-926